



Avionics Databus
Solutions



- MIL-STD-1553
- STANAG3910/EFEX
- ARINC429
- AFDX®/ARINC664P7
- ARINC825 (CAN bus)
- Fibre Channel
- Ethernet (up to 10 Gbit/s)

PRODUCT GUIDE

Interface
Modules

Analysis
Software

Systems
Solutions

Avionics Databus Solutions

Company Profile



With more than 35 years in the business, ► AIM GmbH is a leading designer and manufacturer of high quality and advanced avionics test and simulation modules, embedded interfaces, databus test and analysis software, data loaders and complete system solutions.

AIM has offices in the UK and USA with the main design and manufacturing facilities based in Freiburg, Germany.

Our full service technical web site offers online downloads providing product updates and a full documentation service.

AIM markets and supports its products through qualified and authorized representatives worldwide.

AIM offers the complete solution for

- MIL-STD-1553,
 - STANAG3910/EFEX,
 - ARINC429,
 - AFDX®/ARINC664P7,
 - Fibre Channel
 - ARINC825 (CAN bus)
 - Ethernet (up to 10 Gbit/s)
- applications like:

- Design and Development
- Embedded Interfaces
- Test and Integration
- Production Testing
- Validation/Conformance/EMC Testing
- Trials and Analysis
- Data Loading
- In-Service Support and Maintenance

With our broad customer appeal, AIM's products are used by the worlds leading defence and aerospace companies.



AIM's ► PBA.pro™ Databus Test and Analysis Software offers a new generation design to cover a wide range of applications from a stand alone protocol analyzer to a complete systems test bench or advanced avionics integration facility. PBA.pro™ supports single or multiple AIM avionics interfaces and 3rd party hardware resources within a single powerful application framework.

AIM provides turnkey customized system solutions based on PBA.pro™ and AIM modules being at the core of the system. Full documentation, design reviews, project management, installation, training and long term support contracts ensure our clients success.



Included with the AIM solution is responsive and expert pre and post sales, technical support and service. Our qualified and experienced team of application engineers is on hand to help you with the use and integration of any AIM product or system.

Our products are designed and manufactured to the highest quality and our procedures certified to ISO9001 and in accordance with AS9100 Rev. C respectively EN9100. Our quality system is our management tool in order to optimize and continuously improve relevant quality processes and guidelines within AIM. Quality is our AIM!

Interface Modules

AIM's innovative, unique and successful ► 'Common Core' hardware design set new standards for onboard intelligence and performance when introduced to the market in 1998. Since then, further generations and evolutions of the Common Core approach have been introduced, offering improved performance, higher channel density, lower power consumption, the migration to smaller form factors as well as the support of new avionics bus and network communication standards. Maintaining full functionality and compatibility to the previous generations of products is a high priority requirement for any new generation of AIM interface products.

The latest generations of the Common Core design which are incorporating SoC (System on Chip) hardware components are addressing today's and tomorrow's needs for smart and intelligent interface types, up to portable devices with standalone capability.

The AIM hardware design includes the flexibility and growth potential for our clients to maximize their investment over an extended life cycle of any AIM product. Versions with extended temperature range, conduction cooling, Rear-I/O and conformal coating can be provided for embedded and military applications. AIM's philosophy is to introduce new form factors in line with emerging standards and market demands to supply our large installed customer base.

For fast and effective product integration AIM includes with the supply of our modules full function driver software for a variety of operating systems:

- Windows
- Linux
- LabVIEW/VI's, LabVIEW/RT
- VxWorks
- others on request

A Board Software Package (BSP) includes the required drivers, user's manuals and example code to ease the development and integration task.

Common Core Advantage:

- Onboard Application Support Processor (ASP) on SoC basis with additional peripheral interfaces provisions
- Multiple Bus Interface Unit (BIU) Processors
- Host backplane Bus Master Capability
- Deterministic Timing and hard real-time capabilities onboard
- Common Application Programming Interface (API) – easily portable between Hardware Platforms
- Flash the Firmware for in-field Updates – latest Versions available from Web Site 'Download Area'
- Compatible with PBA.pro™ Databus Test and Analysis Tool and AIM DataLoader Applications

Test & Simulation Modules

MIL-STD-1553

AIM's ► MIL-STD-1553 modules provide up to 8 dual redundant buses on a single card and operate concurrently as Bus Controller, Multiple Remote Terminals (31) and Chronological/Mailbox Bus Monitor.

SUPPORTED FORM FACTORS

PCle • PMC • XMC • PXI • PXIe • CPCle
PCle Mini Card • Ethernet • USB • VME

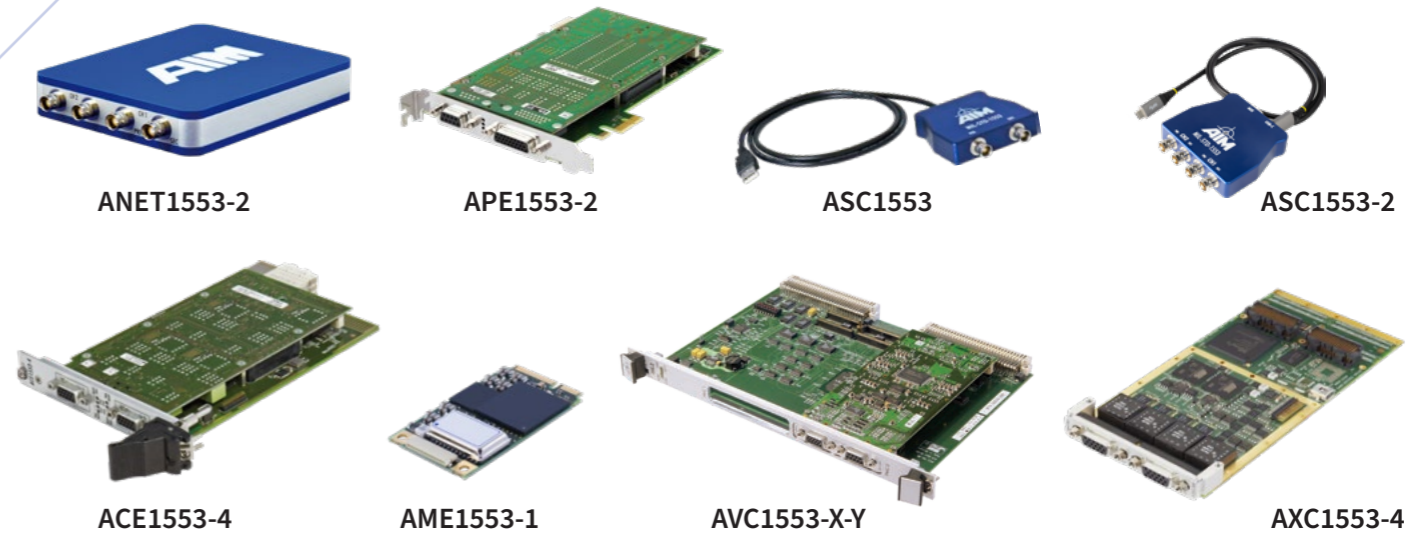

Common features:

- Comprehensive Onboard Processing
- Protocol Error Injection/Detection
- Onboard Global Memory for Control and Data Structures
- IRIG-B Time Encoder/Decoder for Time Tagging
- General Purpose Discrete I/O's (Avionics Level on selected Modules)
- Real Time Recording and Physical Bus Replay
- Multi-Level Triggering for Capture/Filtering
- Single Function/Simulator Only Versions available
- Application Programming Interface and Driver Software Support included

Databus Test & Analysis Software:

MIL-STD-1553 resource components (PBA.pro-MIL) and database components (PBA.pro-1553-DBM) are available for the PBA.pro™ Databus Test and Analysis Tool to support single or multiple MIL-STD-1553 modules with BC, Multi RT Simulation, Bus Monitoring/Recording and Physical Replay functionality as well as Parameter level support.

PBA.pro – Special features:

- Optional Scripting Packages to support Electrical and Protocol Tests of AS4112 RT Production Test Plan and Protocol Tests of AS4111 RT Validation Test Plan
- Built-In Feature for Graphical Visualization of Simulated and Monitored Traffic
- Statistical Analysis and Message Resolving Features of Chronologic Traffic
- Support Generation of BC Simulations based on Monitored Traffic
- Import of legacy PBA-2000 Setup and Recording/Replay Files

Unique features

- ► MILScope™ Option for MIL-STD-1553 electrical Waveform Verification
- Execution of Python Scripts with the ► ANET (Ethernet based form factor) Onboard Linux OS

SIMPLIFIED COMMON CORE ARCHITECTURE

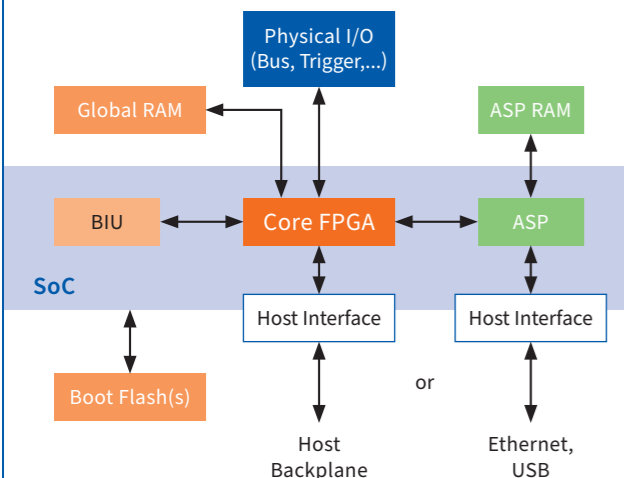

DRIVER SOFTWARE ARCHITECTURE

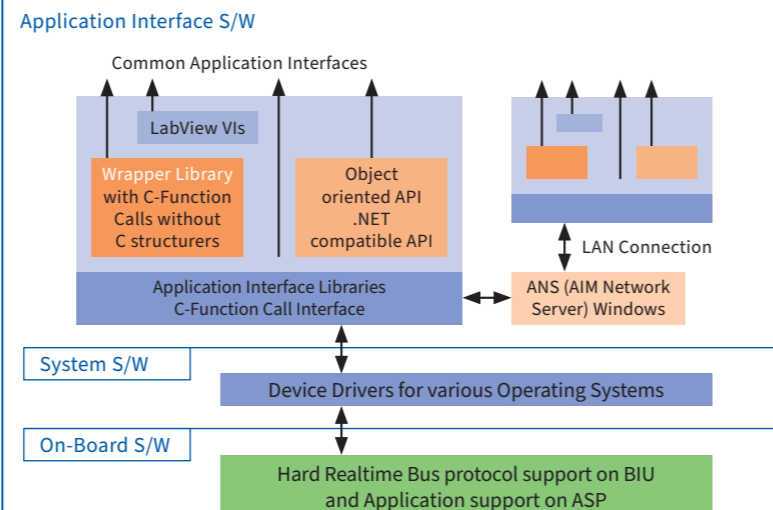

STANAG3910/EFEX

AIM's ► **STANAG3910/EFEX** modules provide 1 or 2 dual redundant HS/LS buses on a single card (with onboard Fibre Optical Front End or Electrical Front End) and operate concurrently as HS/LS Bus Controller, Multiple Remote Terminals (31) and Chronological/Mailbox Bus Monitor.

SUPPORTED FORM FACTORS

PCIe • PXIe • CPCle • Ethernet • XMC • VME

ARINC429

AIM's ► **ARINC429** modules provide up to 64 ARINC429 channels on a single card, individually programmable as Transmitter or Receiver channels for high speed or low speed transmission rates.

SUPPORTED FORM FACTORS

PCIe • PMC • XMC • PXI • PXIe • CPCle
Ethernet • USB • VME



ANET3910

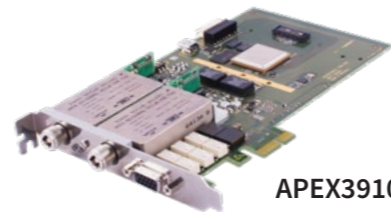

APEX3910



ACE3910



AXC3910



ANET429



APE429

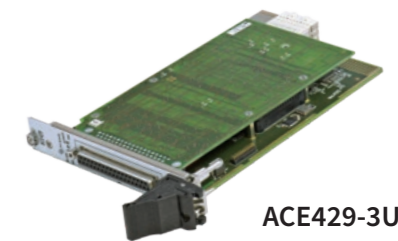

ACE429-3U-16



AVC429-X-Y



AXC429-32



ASC429

Common features:

- Comprehensive Onboard Processing
- Protocol Error Injection/Detection
- Large Scale Global Memory
- IRIG-B Time Encoder/Decoder for Time Tagging
- General Purpose Discrete I/O's (Avionics Level on selected Modules)
- Real Time Recording and Physical Bus Replay (electrical and optical)
- Multi-Level Triggering for Capture/Filtering
- Support for Direct Digital Links (DDL's) and Fibre Optic DDL (FODDL)
- Versions available with Onboard Electrical Front End (for Rafale)
- Single Function/Simulator Only Versions available
- Application Programming Interface and Driver Software Support included

Databus Test & Analysis Software:

STANAG3910/EFEX resource components (PBA.pro-STANAG) and database components (PBA.pro-STANAG-DBM) are available for the PBA.pro™ Databus Test and Analysis Tool to support single or multiple STANAG3910/EFEX modules with BC, Multi RT Simulation, Bus Monitoring/Recording and Physical Replay functionality.

PBA.pro – Special features:

- EFA/EFEX Switching on the fly
- Built-In Feature for graphical Visualization of simulated and monitored Traffic (LS and HS)
- Support for Resolving monitored Transactions to user definable Identifiers/Names
- Support Generation of BC Simulations based on monitored Traffic
- Import of legacy PBA-3910 Setup and Recording/Replay Files
- Optional Scripting Package to support Protocol Tests of EFABus RT Production Test Plan

Unique feature

- Execution of Onboard Customer Applications, Python Scripts with the ► **ANET** (Ethernet based form factor) Onboard Linux OS

Common features:

- Comprehensive Onboard Processing
- Software Programmable Tx or Rx Channels with High/Low Bit Rate
- Cyclic/Acyclic Label Transmission
- Label Rate oriented Transmission Mode
- Dynamic, FIFO based Transmission Mode for application scenarios with demand for high flexibility
- Protocol Error Injection/Detection
- Large Onboard Memory for complex, real-time simulation scenarios
- IRIG-B Time Encoder/Decoder for Time Tagging
- General Purpose Discrete I/O's (Avionics Level on selected Modules)
- Real Time Recording and Physical Bus Replay
- Multi-Level Triggering for Capture/Filtering
- Support for Loop/Pollution Mode
- Application Programming Interface and Driver Software Support included

Databus Test & Analysis Software:

ARINC429 resource components (PBA.pro-ARINC429) and database components (PBA.pro-ARINC429-DBM) are available for the PBA.pro™ Databus Test and Analysis Tool to support single or multiple ARINC429 modules with Transmitter/Receiver Simulation, Bus Monitoring/Recording and Physical Replay functionality as well as Parameter level support.

PBA.pro – Special features:

- Compatible Database with Engineering Unit Definition of ARINC429 Standard Labels and Equipment ID's. Available as an 'App' for free download via web
- Support for Loop/Pollution Mode of Interface Modules
- Scripts for Databus Import of Airbus and Boeing ICDs

Unique feature

- Execution of Python with the ► **ANET** (Ethernet based form factor) Onboard Linux OS

AFDX®/ARINC664P7

AIM's ► AFDX®/ARINC664P7 modules provide up to 2 dual redundant AFDX® channels on a single card and operate concurrently in traffic simulator or receiver/monitor modes.

SUPPORTED FORM FACTORS

PCIe • PMC • XMC • PXIe • CPCle • USB

ARINC825 (CAN Bus)

AIM's ► ARINC825 (CAN bus) modules provide up to 4 ARINC825 (CAN bus) channels on a single card and operate concurrently as Transmitter or Receiver channels.

SUPPORTED FORM FACTORS

PCI • PCIe • CPCle • USB • PMC • VME

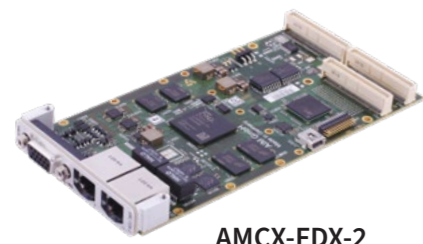

AMCX-FDX-2



AXC-FDX-2



ACE-FDX-3U

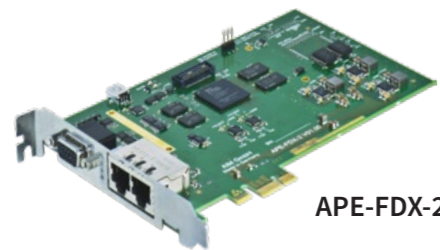

APE-FDX-2



ASC-FDX-2



ACC825-3U

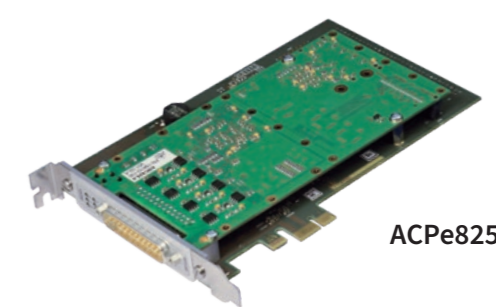

ACPe825-x



AMC825



APU825

Common features:

- Comprehensive Onboard Processing
- Programmable Ports for Single or Dual Redundant Operation
- Generic, UDP Port oriented or Replay Transmit Mode
- Chronological or UDP/VL oriented Receive Mode
- Protocol Error Injection/Detection
- Large Scale Global Memory
- IRIG-B Time Encoder/Decoder for Time Tagging
- Multi-Level Triggering for Capture/Filtering
- Variants available with Boeing specific EDE extensions
- Application Programming Interface and Driver Software Support included

Databus Test & Analysis Software:

AFDX®/ARINC664P7 resource components (PBA.pro-AFDX®) and database components (PBA.pro-AFDX®-DBM) are available for the PBA.pro™ Databus Test and Analysis Tool to support single or multiple AFDX®/ARINC664P7 modules with Tx/Rx E/S Simulation, Generic Tx Modes, Network Monitoring/Recording and Physical Replay functionality.

PBA.pro – Special features:

- Import of legacy fdXplorer Setup Files
- Scripts for Database Import of Airbus and Boeing ICDs
- Support for Boeing specific extensions

Unique Software solution for Data Loading/ARINC615-A:

EasyLoad-615A, ready to use ARINC615-A Dataloader software package for AIM's AFDX®/ARINC664P7 cards or standard Ethernet incl. ARINC665 Media Set Generating Function.

Unique Hardware solutions

- Redundancy Management/Handling, Traffic Shaping Simulation/Verification onboard
- Compatible to µAFDX®
- Digital TAP Function built-in

Common features:

- FPGA based CAN Controllers
- Additional 32-bit Microcontroller inside FPGA (Application Support Processor)
- Support of 11-bit and 29-bit CAN ID's (in accordance with CAN 2.0B specification)
- Cyclic/Acyclic ID Transmission Mode
- Full Receiver or Listener Mode
- Chronological (FIFO) and ID oriented (Object) Receive Mode
- Protocol Error Detection
- IRIG-B Time Decoder for Time Tagging of CAN frames with 1µs resolution
- Application Programming Interface and Driver Software Support included

Databus Test & Analysis Software:

ARINC825 (CAN bus) resource components (PBA.pro-CAN) are available for the PBA.pro™ Databus Test and Analysis Tool to support single or multiple ARINC825 (CAN bus) modules with Receiver, Transmitter Simulation and Monitoring/Recording functionality. Resource components include Database Manager functions for engineering unit conversion.

PBA.pro – Special features:

- Database Support for Decoding of CAN ID related Payload included in the Resource Component
- Activity Display for CAN ID's
- Support for ARINC825 interpretation of the 29-bit ID's
- Scripts for Database Import of Airbus and Boeing ICDs

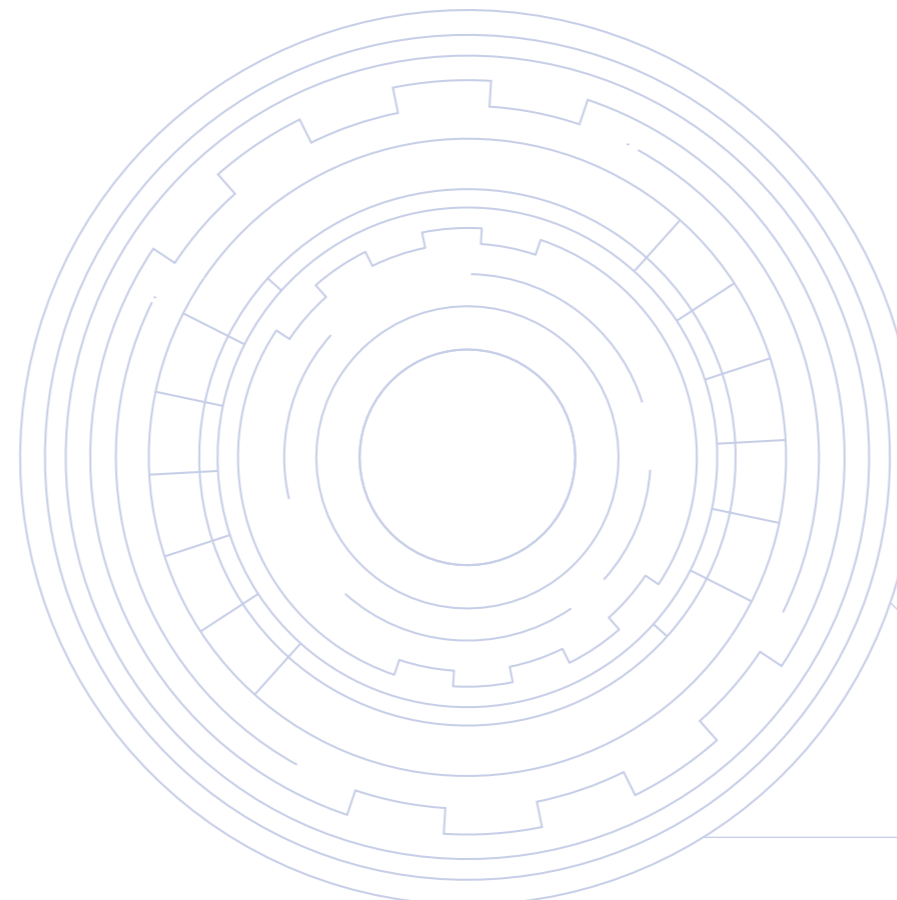

Fibre Channel

The ► **Fibre Channel** modules from AIM GmbH provide up to 2 ports on a single interface card, offering data generation/simulation and monitor/analyzer functions.

SUPPORTED FORM FACTORS

PCIe • PXIe

Carrier

To complement the wide range of interface modules for dedicated Avionics Databuses and Networks, AIM offers a range of ► **Carrier modules** for the use of AIM or any 3rd Party PMC and XMC module on various backplanes.

PMC-to-PCI • PMC-to-PCIe • XMC-to-PCIe
 PMC-to-VME • PMC-to-VME (conduction cooled)
 PMC-to-CPCI 3U • XMC-to-CPCIe 3U

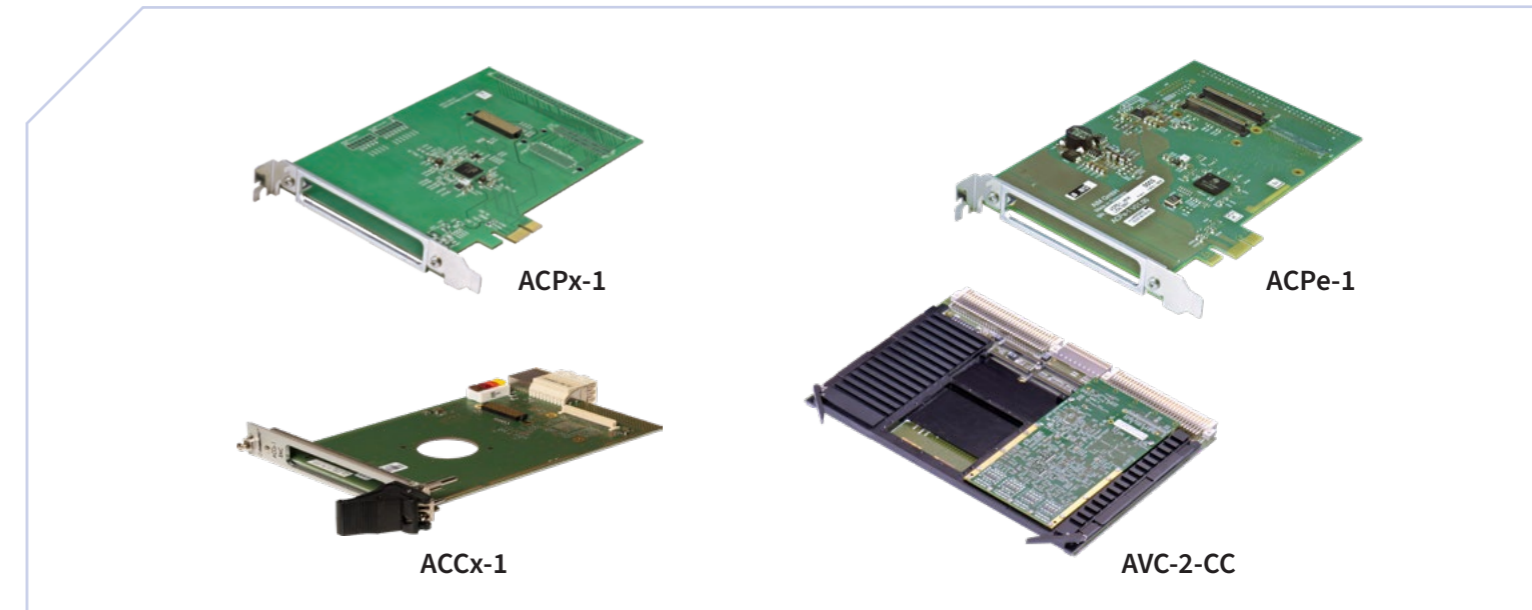
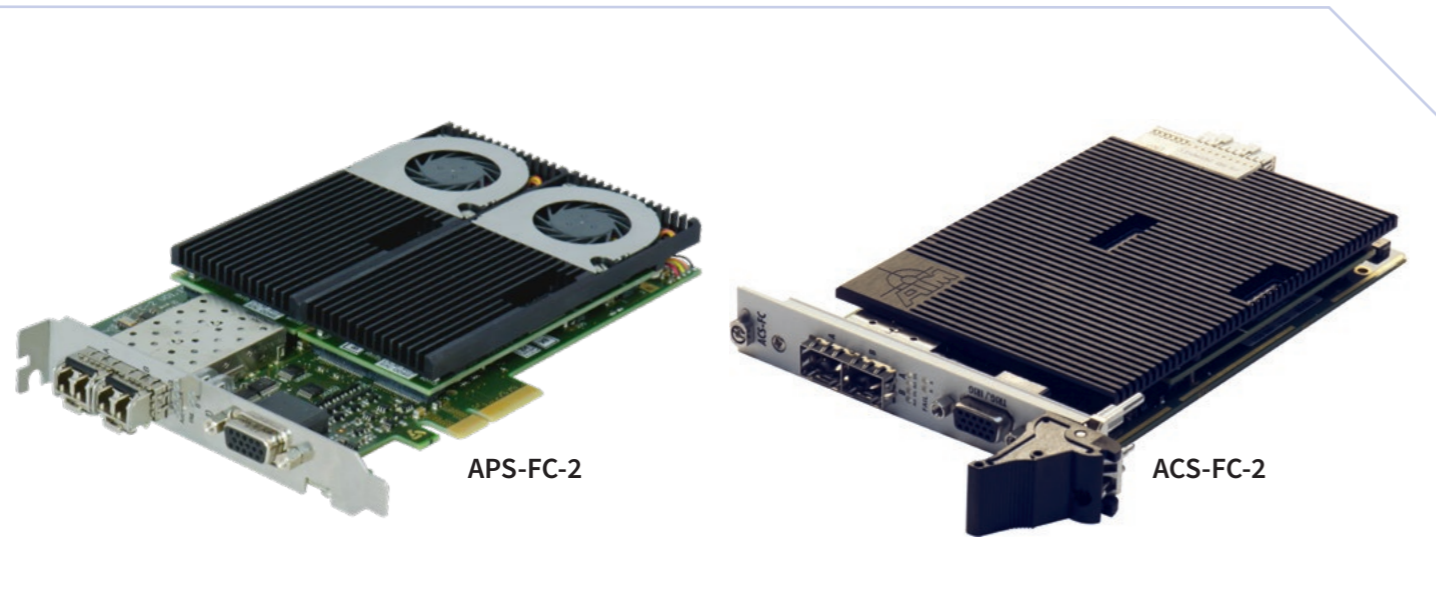

Common features:

- Simulation and Monitoring of FC-2 compliant network traffic for data rates up to 4GFC
- Onboard IRIG-B Time Encoder/Decoder with 10ns resolution for Time stamping
- 4 Trigger Inputs and 4 Trigger Outputs
- Network TAP functionality for analyzing traffic in Real-Time and inline between 2 attached FC Ports

Databus Test & Analysis Software:

The PBA.pro-FC component handles single or multiple Fibre Channel resources providing access to all Capture and Send Ports with Network Databus Analyzer functions.

PBA.pro – Special features:

- Realtime traffic visualization and capturing
- Decoding of captured Frames of FC-1, FC-2 and FC-4 Layers
- Flexible frame generation with full control over all FC frame bytes and parameters
- Database Manager Component to support Engineering Unit Conversion

Application Programming Interface for C/C++ as well as Driver Software Support for Windows and Linux included.

Fibre Channel modules

- **APS-FC-1/2**
 - 1 or 2 Port Fibre Channel Interface with up to 4GFC (fully software configurable)
 - PCIe2.0 (4x) Host Interface
 - 1 Dual Core processor per Port
 - 4 GByte DDR3 RAM per Port
 - SFP Frontend

Cables & Accessories

AIM offers a variety of cables for use with our modules, databus analyzers and systems.

For MIL-STD-1553 applications we offer an off the shelf range of Bus Couplers, Cables and Terminators and complete Bus Kits to meet all your MIL-STD-1553 test and development needs.



Rugged Embedded Modules

AIM ► MIL-STD-1553 and ARINC429 modules are available in a variety of standard rugged embedded form factors for flight and other rugged applications.

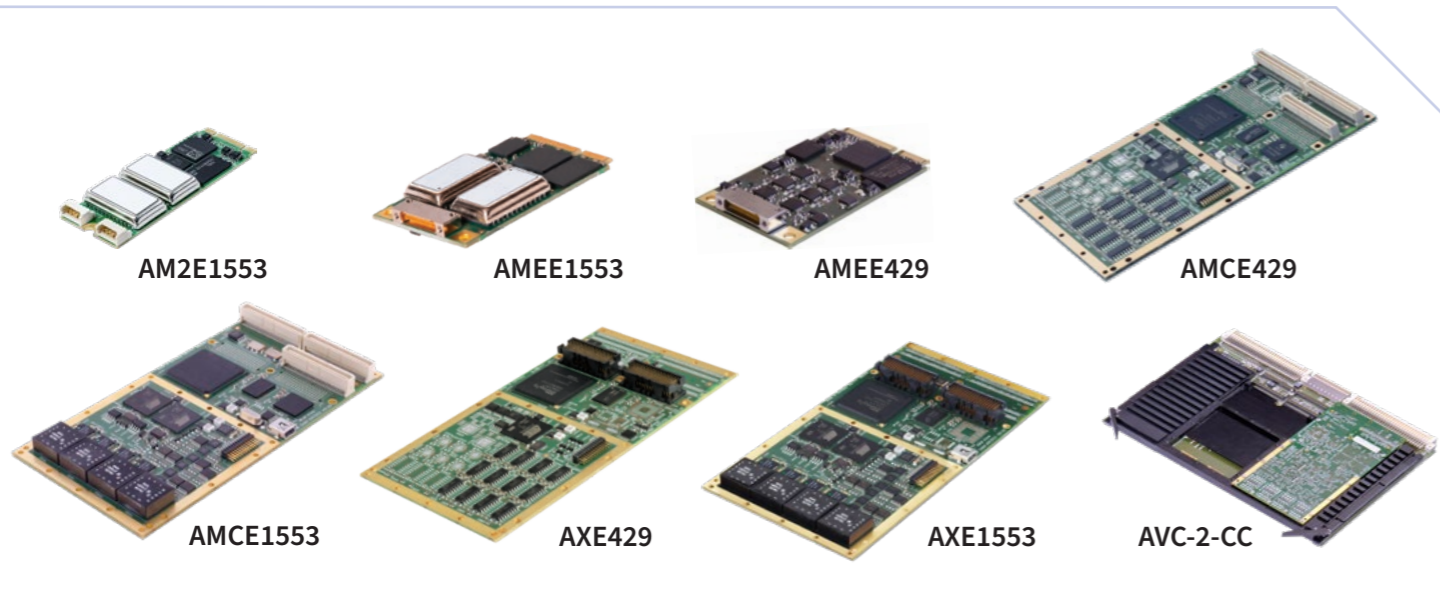

For the most demanding embedded ► MIL-STD-1553 and ARINC429 applications AIM offers MiniPCIe-based (AMEE1553 and AMEE429), XMC based (AXE1553-x and AXE429-x) as well as PMC based (AMCE1553-x and AMCE429-x) interface boards.

These modules are designed with the below features, making them an ideal solution for harsh environments.

- Low Power Dissipation
- Extended Temperature Range from -40° to +85°C
- Conduction Cooling
- VITA 47 Shock and Vibration Qualification
- XMC Rear-I/O
- Avionics Level Discretes
- Trigger I/O

Provisions for inhibiting transmitter functions and disabling error injection are supported. Conformal coating is available as an option.

The AM2E1553-x (Type 2260 (default)/ Type 2280 (optional), Key B/M) as well as the AMEE1553-x can handle 1 or 2 dual redundant MIL-STD-1553 buses. 1, 2 or 4 dual redundant MIL-STD-1553 buses can be handled by the AXE1553-x/AMCE1553-x and 4, 8 and 12 ARINC429 channels by the AMEE429-x and 4, 8, 16 and 32 ARINC429 channels by the AXE429-x/AMCE429-x.

Mixed Protocol Modules



ANET-MxAy

The ► ANET-MxAy offers mixed protocol support, combining MIL-STD-1553 and ARINC429 data bus test and simulation capabilities in 1 ANET device.

Mixed Protocol ANET modules can be offered in various configurations with up to 2x MIL-STD-1553 and 12 ARINC429 channels.

The MIL-STD-1553 section offers concurrent Bus Controller, Multiple RT Simulator (31) with Mailbox and Chronological Monitor functions.

All ARINC429 channels are fully software programmable for Tx/Rx mode as well as low (12.5kBit/s) and high speed (100kBit/s) operation.

All standard ANET auxiliary signals like 8 Discrete I/O's, Trigger I/O, IRIG-B I/O as well as a general purpose USB2.0 port (to host USB devices) are available for the mixed protocol ANET version.

Unique feature

- Execution of Onboard Customer Applications, Python Scripts with the ANET (Ethernet based form factor) Onboard Linux OS

Rugged ANET

The AIM ANET devices for MIL-STD-1553, ARINC429 and mixed protocol (MIL-STD-1553 and ARINC429) can optionally be offered in a rugged housing.



Rugged ANET

With a ► rugged housing and sealed standard connector types for all ANET I/O signals, the Ethernet based AIM ANET interfaces can be used for more rugged applications.

A wide range 9...36VDC power supply input per default allows the use in avionics typical 28VDC environment.

All standard ANET auxiliary signals like Discretes, Trigger I/O, IRIG-B as well as a general purpose USB2.0 port (to host USB devices) are available for the rugged version.

The rugged ANET can be offered in various configurations with up to 2x MIL-STD-1553 and 12 ARINC429 channels (max. 12 ARINC429 channels for the mixed protocol ANET variant).

Customized connectors (e.g. circular types) can be offered on request.

Environmental Specifications:

Shock, vibration, humidity, altitude: MIL-STD-810G

EMC: EN 55022: 2011-12, EN 55024: 2011-09

Software

Test, Simulation, Analysis Solutions

The PBA.pro™ is the AIM core software platform for Avionics Test and Analysis application with AIM's family of high performance avionics test and simulation interface modules plus a wide range of 3rd party hardware. PBA.pro™ is modular, scalable and customizable by the user to cover a wide range of applications in an extremely efficient manner.

The PBA.pro™ software runs on Windows and Linux platforms and integrates the essential features for today's and tomorrow's Avionics test, development, simulation, monitoring and analysis applications.

Various customization capabilities via scripts, user defined panels and dedicated GUIs support the PBA.pro™ for use as a simple databus protocol analyzer up to system test and integration tool for handling multiple data buses via single software solution.



Core functionality:

- Modular, scalable and integrated Software platform
- Support for Windows and Linux
- Fully automatable and customizable via Scripts, Remote Control and User Dialogs
- Manage single or multiple AIM Avionics Interfaces and 3rd Party Hardware resources within a single Framework
- Software Platform for:
 - Low and High Level Protocol/Network Analyzers
 - Recording/Monitoring/Data Logging Systems
 - Special-To-Type Test Equipment (STTE)

- Test Benches and Integration Rigs
- 'Hardware in the Loop' Simulation Rigs
- In-Service and Maintenance Toolsets
- Flexible Licensing Options (Full, Light, Runtime)
- PBA.pro Server/Client support for data distribution to multiple Workstations
- Complete Add-On Script Packages to support:
 - AS4111 and AS4112 Test Plans
 - EFABus RT Production Test Plan
 - ARINC664P7 End System/Switch Compliance Tests
- Useful PBA.pro Utility Scripts, Panels, etc. are available via AIM Download Area

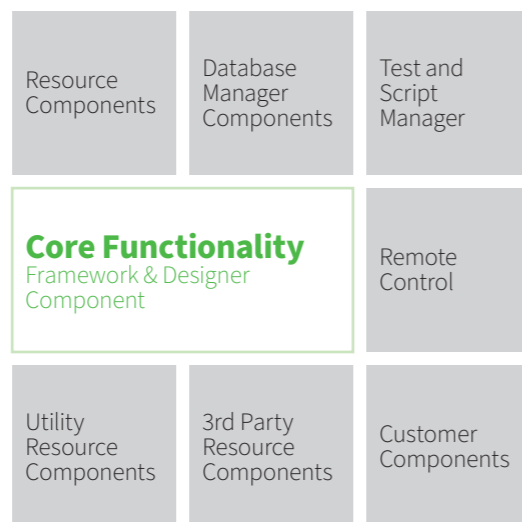

PBA.pro™ – modular, scaleable and integrated approach for a broad range of avionics applications.

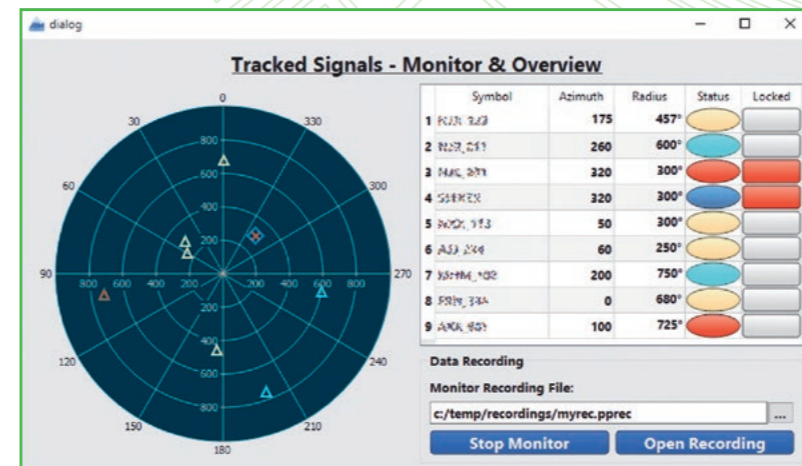
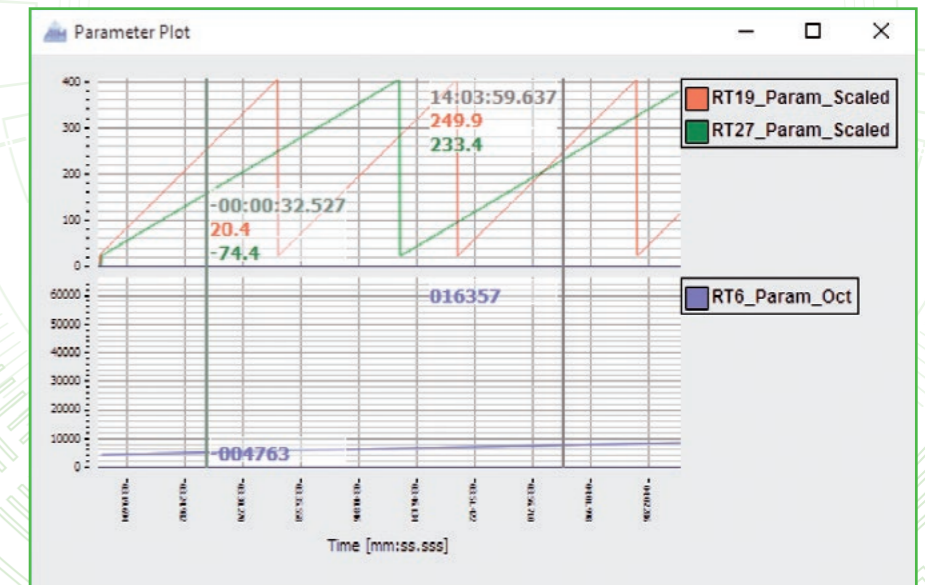
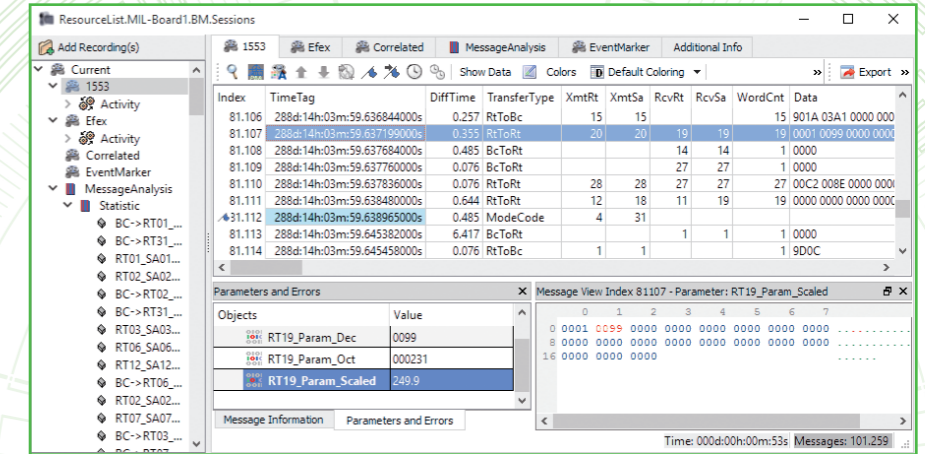
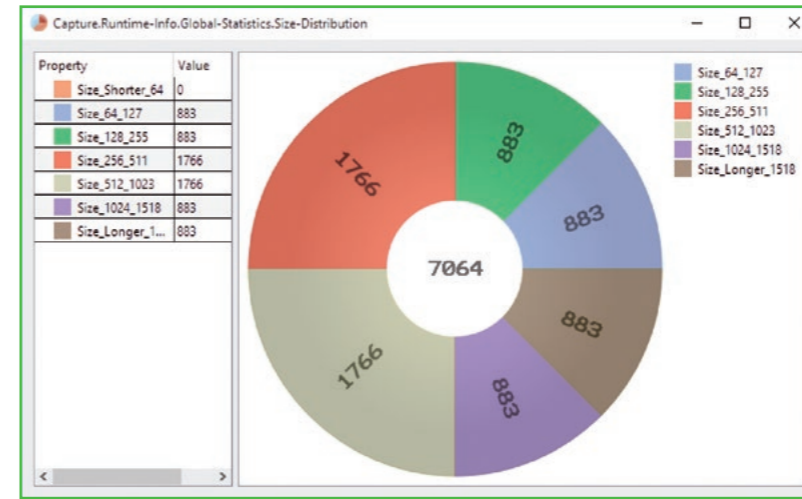

Data Loading Software

For ► **Data Loading** requirements AIM provides software solutions for ARINC615A (over Ethernet, AFDX®/ARINC664P7) which works together with the corresponding AIM interface modules.



EasyLoad-615A

► **EasyLoad-615A** is the DataLoader GUI application which performs 615A Data Loading operations via Standard Ethernet ports (NICs) as well as via AIM's AFDX®/ARINC664P7 by supporting 615A Upload, Download, FIND, INFORMATION operations.

A built-in MediaSet generation capability and remote control supports a seamless integration of the tool into the Data Loading work flow.

Training & Services



PBA.pro™ Training Courses

AIM offers a range of ► **training courses** for PBA.pro™ users at all levels. Our comprehensive training courses are conducted by expert trainers and can be adapted to individual needs and requirements. Furthermore, we offer special tool customization and development services as an optional, costed item.

- Basic PBA.pro™ Tool Introduction – 1 Day
- In Depth PBA.pro™ Workshop focussing on the customer's specific interests – 2 Days
- PBA.pro™ Component Programming Workshop for writing your own PBA.pro add-on component – 2 Days

Training courses can be offered on-site as well as online.



System Solutions

Customized Systems

AIM's systems group provides a wide range of customized solutions:

- Special-to Type Test Equipment (STTE)
- High Level Bus Analyzers
- Data Acquisition Recording and Simulation Systems
- Aircraft Ground Equipment (AGE)
- MIL-STD-1760 Weapon Test Sets
- Fibre Optic MIL-STD-1553 Stub/ARINC429 Link Extension System (FOMIS/FOL)

PBA.pro™ is used as the baseline for all our customized system solutions in conjunction with AIM's modules, 3rd party interfaces and Commercial Off The Shelf (COTS) equipment.

The flexibility and scalability of the PBA.pro™ concept with its components offers a set of comprehensive 'Building Blocks' for customized systems.

Full documentation, design reviews, project management, installation, training, long term support contracts and the AIM expertise in customized systems guarantee your success!



AFDX/Ethernet Test System



Aircraft Ground Equipment



High Level Bus Analyzer



Special-to Type Test Equipment

ADock

The ► **ADock ANET** Docking Station offers the capability to host up to 4 AIM ANET Ethernet based data bus interface modules in a single rack. This allows a modular and compact implementation of Test Systems. Furthermore multiple ADocks can be clustered in a network.



ADock-4R

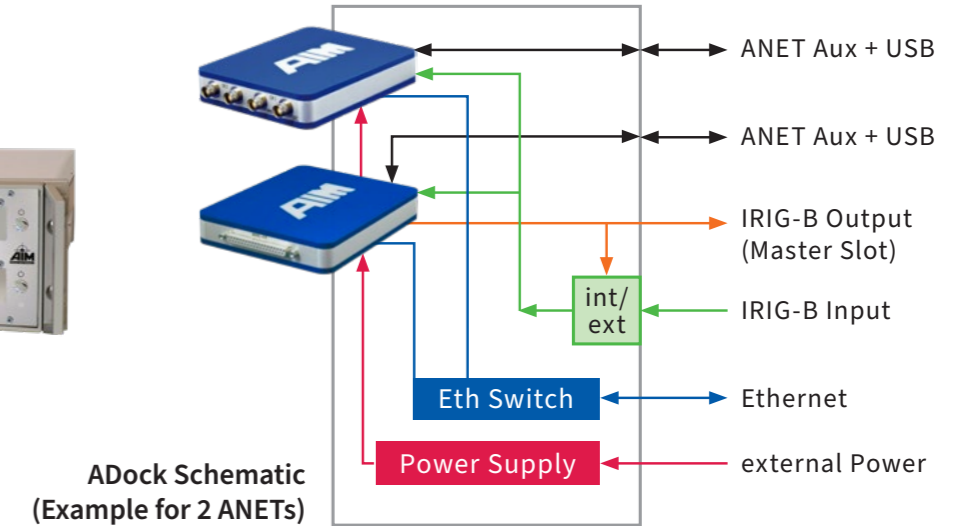

The ADock hosts a single power supply unit for all 4 ANET slots and for the included Ethernet Switch. Per default the ADock is AC powered. The ANETs can be individually powered via dedicated power switches to support a maximum of flexibility via the capability plug/unplug a single ANET without powering down the entire docking station

or other ANETs mounted in the dock. AIM ANET devices are available for MIL-STD-1553, STANAG3910 and ARINC429.

For standalone use of dockable ANETs an adapter is available, offering connectors for Ethernet, USB and Auxiliary signals (IRIG-B, Discretes, Trigger I/O), equivalent to the standard ANETs.



Dockable ANET Standalone Adapter

Bus Extension Systems

With the ► **Fibre Optic Extensions** products, AIM covers a very special niche with solutions for the transparent extension of MIL-STD-1553 and ARINC429 Avionics Databuses over fibre optical links.

Different solutions are offered for Monitoring and Simulation applications in laboratory environment and also in EMC chamber conditions, with hardened implementations of the extension components.



FOL1553 L Base + 5x 1553-L-R-F-T



FOL429-P-T



FOL429-P-R

Full Service Website



PRODUCTS SALES & SUPPORT WHY AIM NEWS & PRESS

Login | Contact Search...

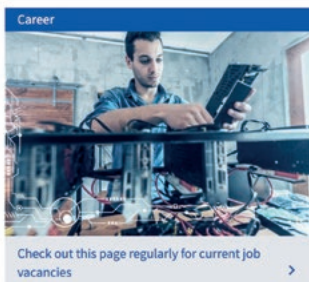
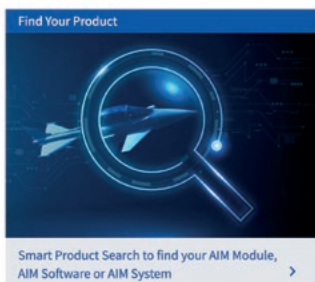

The www.aim-online.com website provides our customers with the very latest product information, technical support, databus tutorials and a rich and powerful download resource maximizing the investment and use of AIM products with an exceptional online experience.

We serve our customers some online features including support for mobile platforms, a product filter and finder plus access to downloads for product related documentation and software directly from the product page.

The website also supports a quick and efficient routing of all your online requests to your AIM sales representative and the AIM technical support team at the head office.



► Visit us at [aim-online.com!](http://aim-online.com)

► AIM Office Contacts:

AIM GmbH

Sasbacher Str. 2
D-79111 Freiburg / Germany
Phone +49 (0)761 4 52 29-0
sales@aim-online.com

AIM GmbH – Munich Sales Office

Terofalstr. 23a
D-80689 München / Germany
Phone +49 (0)89 70 92 92-92
salesgermany@aim-online.com

AIM UK Office

Cressex Enterprise Centre, Lincoln Rd.
High Wycombe, Bucks. HP12 3RB / UK
Phone +44 (0)1494-446844
salesuk@aim-online.com

AIM USA LLC

Seven Neshaminy Interplex
Suite 211 Trevoese, PA 19053
Phone 267-982-2600
sales@aim-online.us

AIM Representative:

